



Passion
Made
Possible

15th
APCNDT 2017
SINGAPORE

APCNDT

Organised by:



CONTENT

15th
APCNDT 2017
SINGAPORE

Agenda

✓ Conference Overview

✓ Attendance Overview

✓ List of Sponsors

APCNDT

CONFERENCE OVERVIEW

15th APCNDT 2017
SINGAPORE

The 15th Asia Pacific Conference for Non-Destructive Testing (APCNDT) was held at Level 4 Marina Bay Sands Expo and Convention Centre on 13 to 17 November 2017.

The conference received 306 abstracts from 252 unique authors representing 30 countries. There were 7 invited keynotes and 1 opening address with 196 oral presentations and 18 poster presentations.

Exhibitions were at Melati and Orchid ballrooms with 81 exhibition booths and 77 unique exhibitors from 23 countries.

APCNDT

Registration Counters	Breakout 2 (B)
Presenters' Desk	Breakout 3 (C)
Exhibition Area	Poster Session/ Breakout 4 (D)
Conference (Opening)	Keynote Session (14-16 Nov)
Breakout 1 (A)	

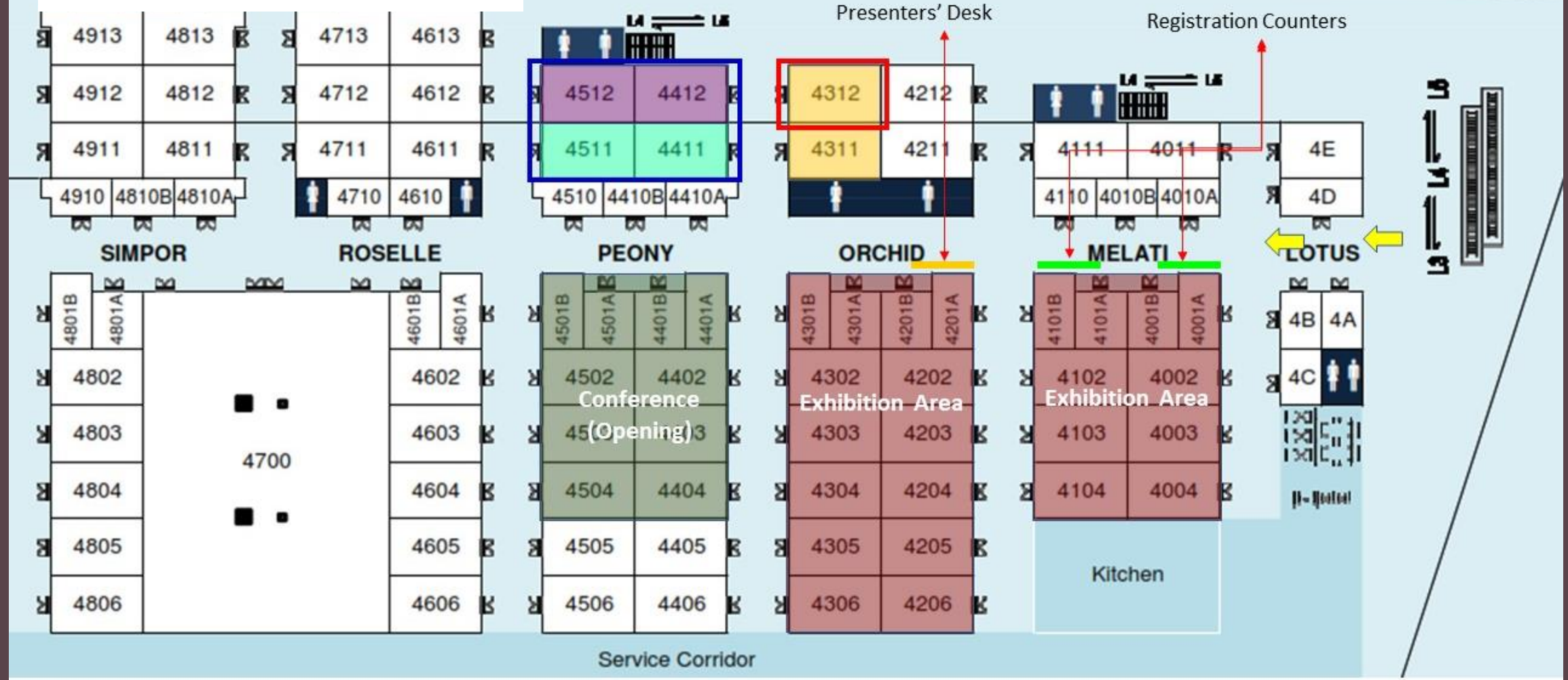

Melati Ballroom

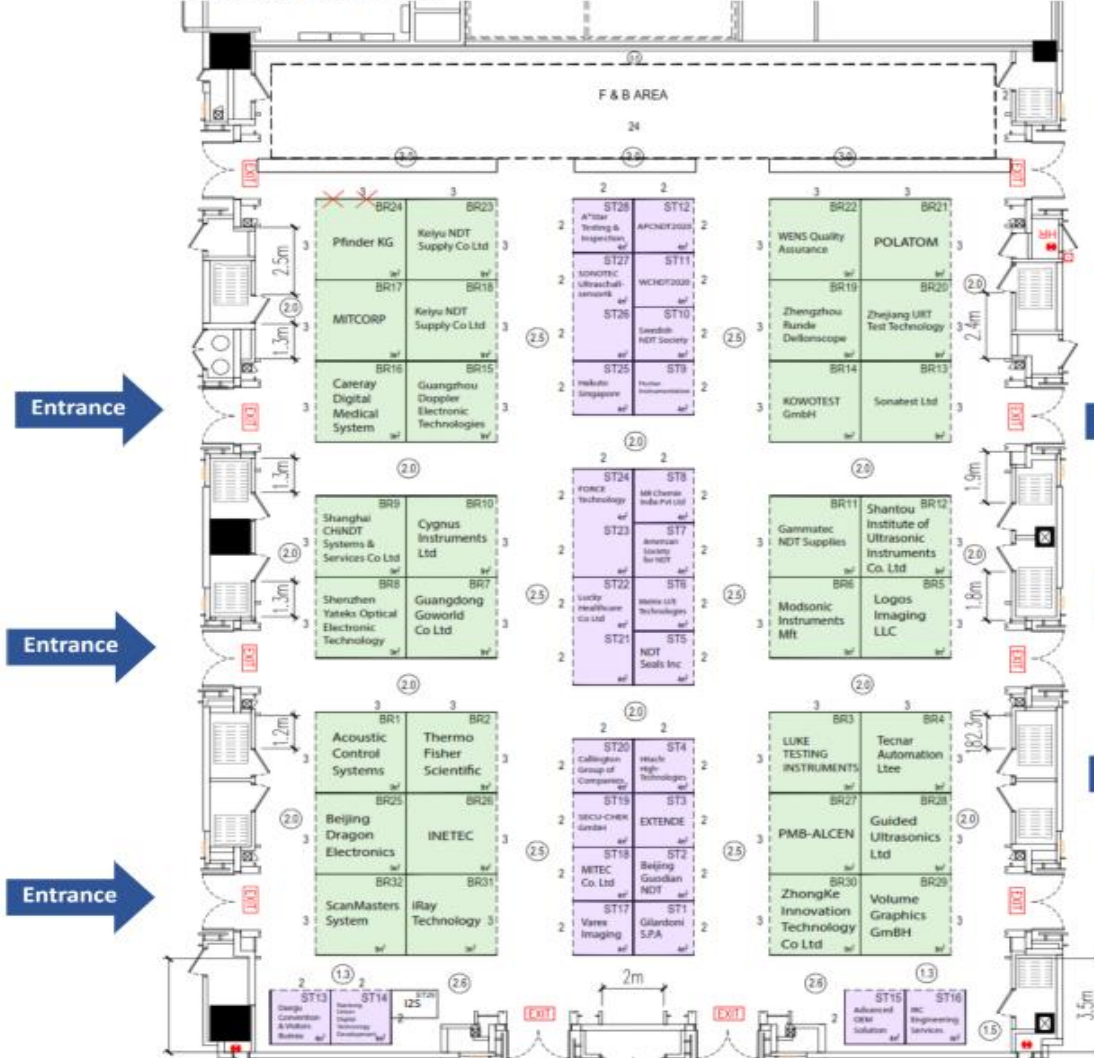

Orchid Ballroom

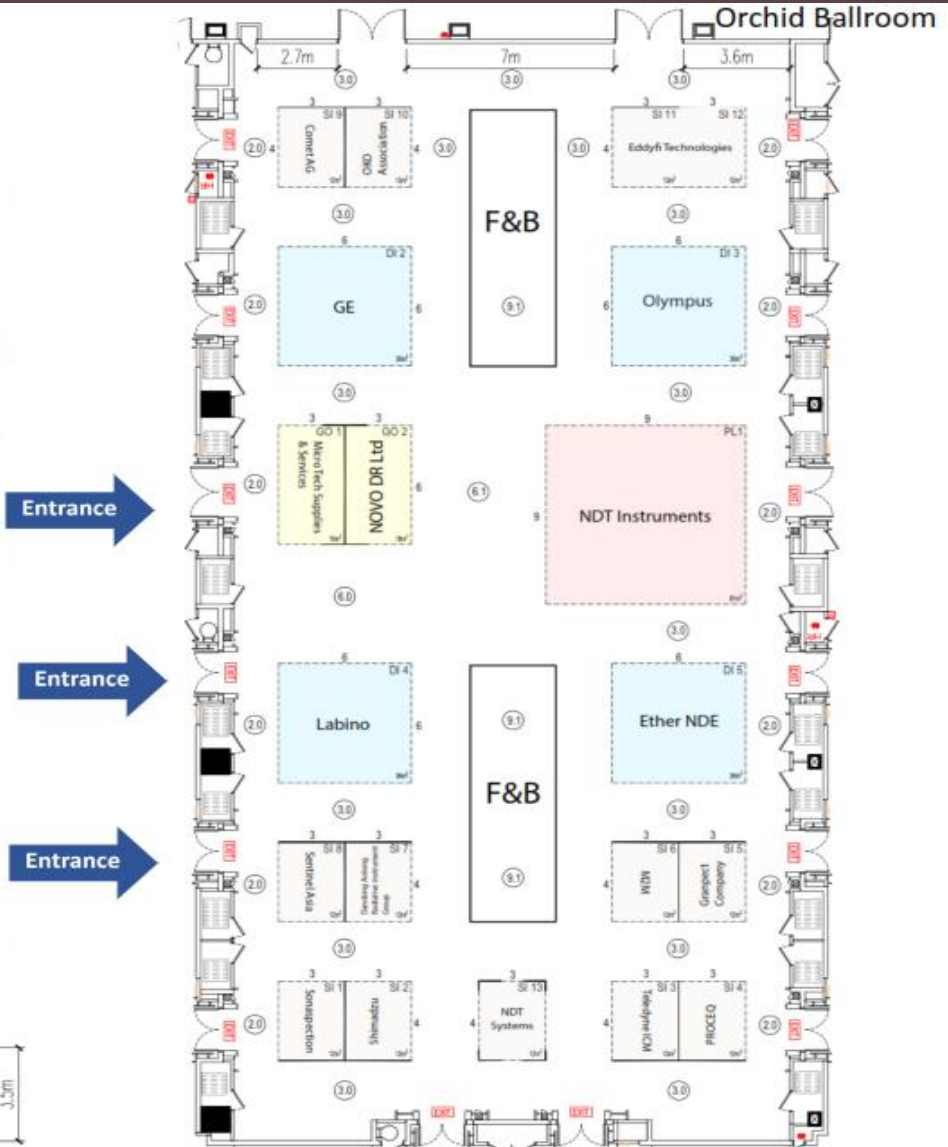

TECHNICAL SESSIONS

15th
APCNDT 2017
SINGAPORE

Sessions				
Date	Breakout A	Breakout B	Breakout C	Breakout D
13 November	Ultrasonic Testing	Certification Magnetic Testing	Other Methods	NIL
14 November	Ultrasonic Testing	Computed Tomography	Other Methods	NIL
15 November	Ultrasonic Testing	Other Methods Structural Health Monitoring	Computed Tomography Radiographic Testing	Ultrasonic Testing Poster Session
16 November	Ultrasonic Testing	Electro-magnetic Testing	Infrared Testing Visual Testing	Other Methods
17 November	Certification	NIL	NIL	NIL

APCNDT

ATTENDANCE OVERVIEW

15th APCNDT 2017
SINGAPORE

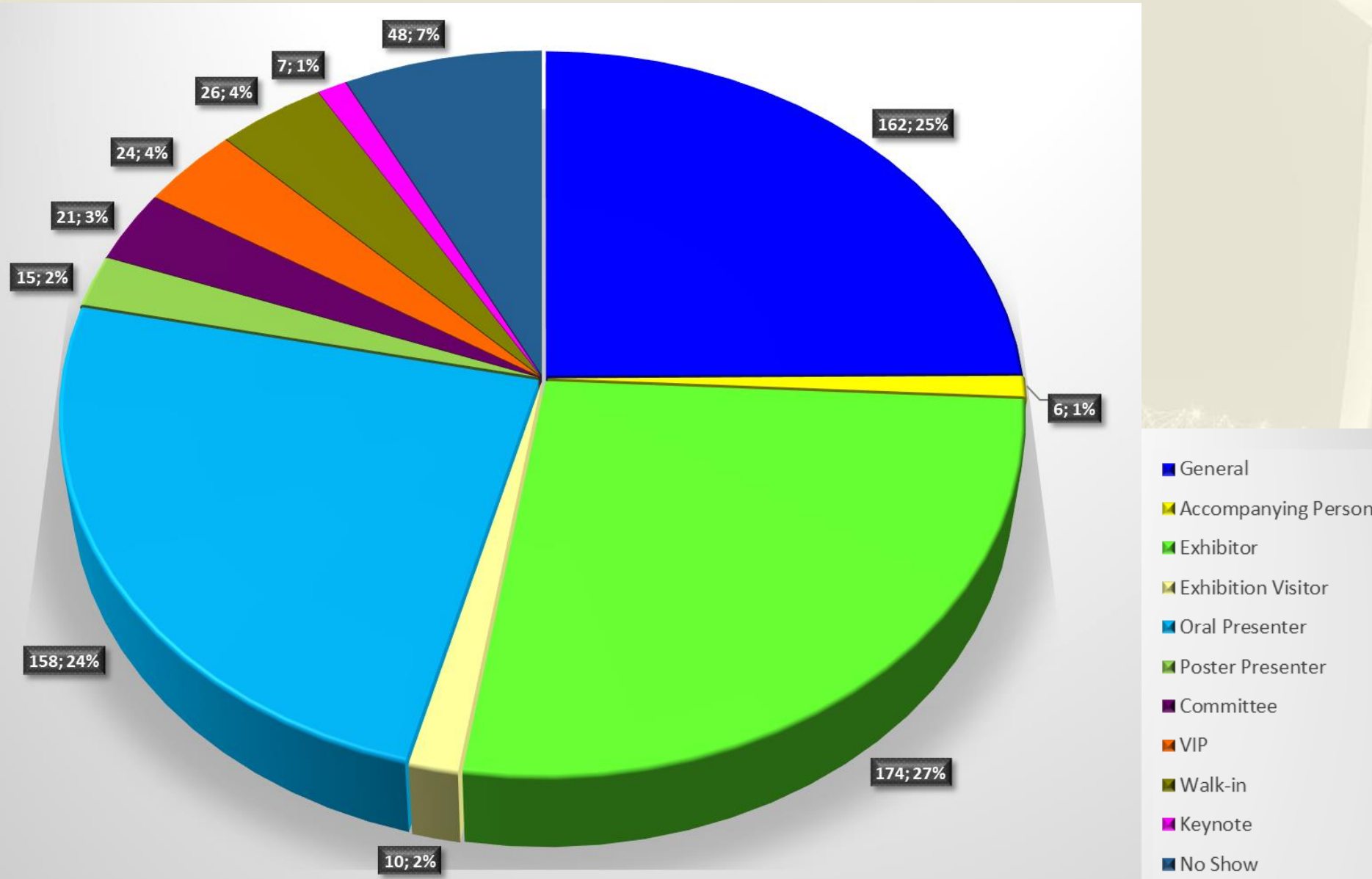

Summary	
Total Pre-Registered	647
Registered and Attended	577
General	162
Accompanying Person	6
Oral Presenter	158
Poster Presenter	15
Committee	21
VIP	24
Keynote	7
Exhibitor Pass	174
Exhibition Visitor	10
Did not attend (No show)	48
Walk-ins	26
Grand Total (Attended + Walk-ins)	603

**ATTENDANCE
OVERVIEW**
Breakdown based
on Category

Overall General Attendees Analysis

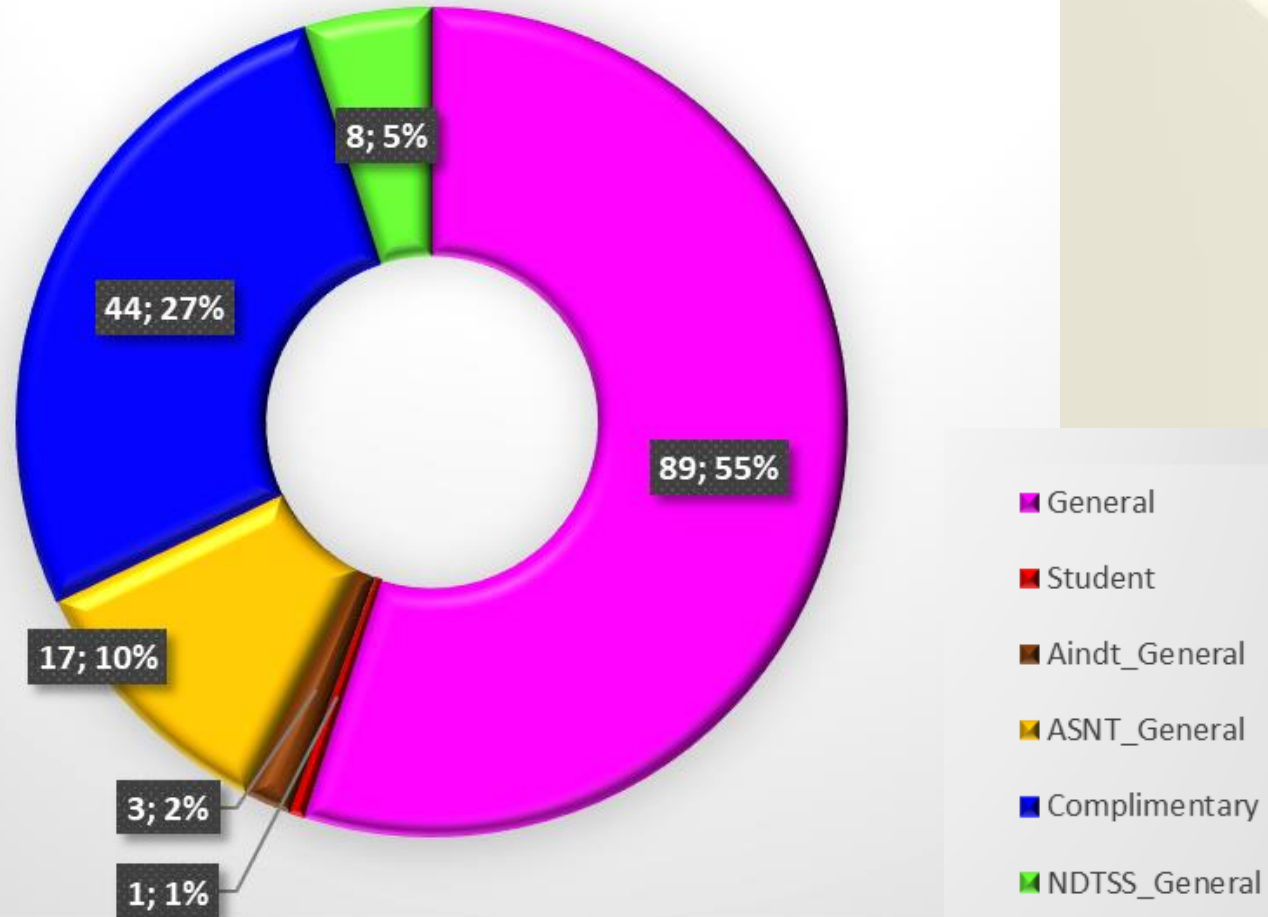

15th
APCNDT 2017
SINGAPORE

Summary	
General	89
Student	1
AINDT_General	3
ASNT_General	17
Complimentary (due to sponsorship entitlement or special arrangement)	44
NDTSS_General	8
Total	162

**ATTENDANCE
OVERVIEW**
Breakdown based
on Category

Overall Oral Authors Analysis

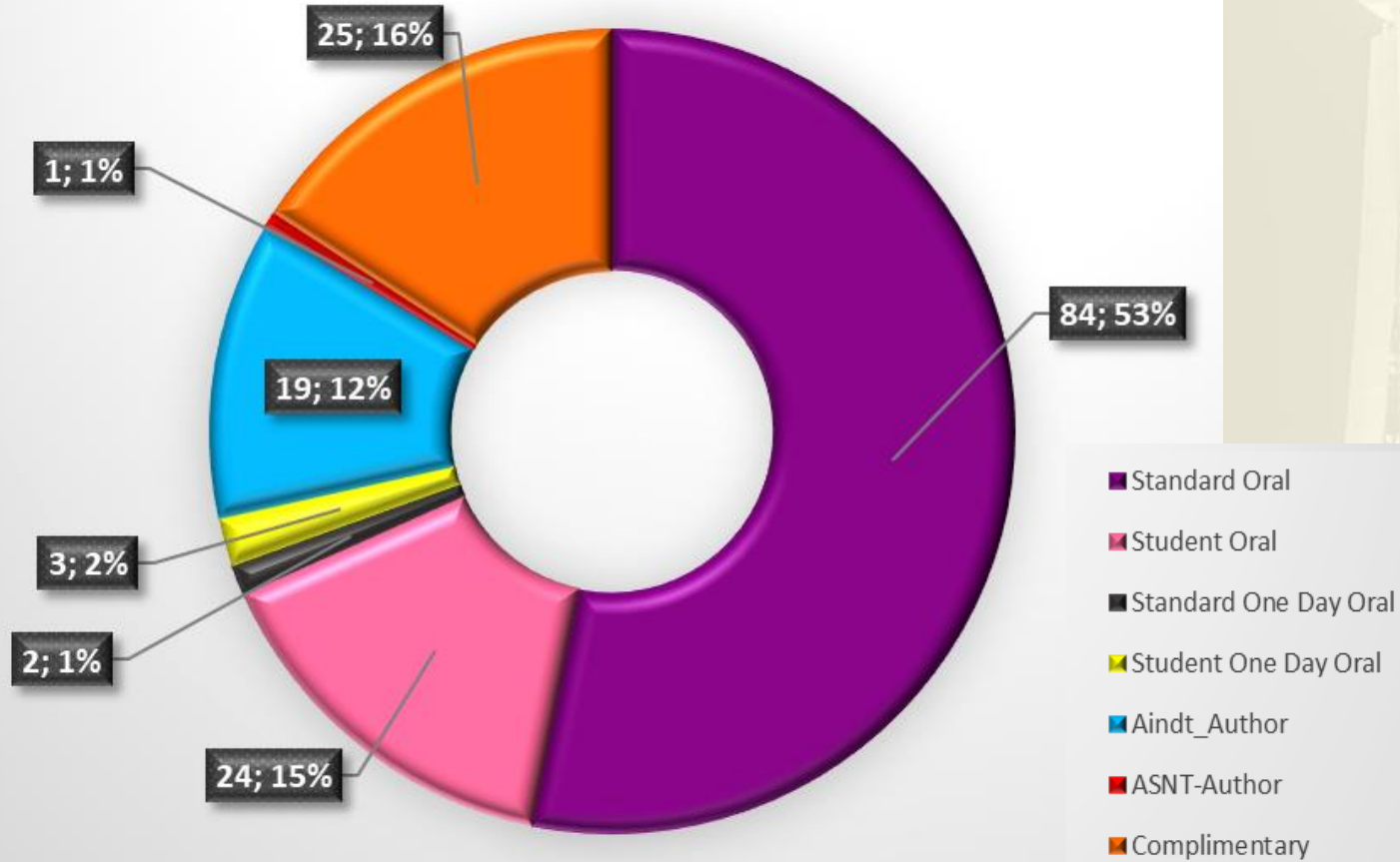

Summary	
Standard Oral	84
Student Oral	24
Standard One Day Oral	2
Student One Day Oral	3
AINDT_Author	19
ASNT_Author	1
Complimentary (sponsorship entitlement)	25
Total	158

**ATTENDANCE
OVERVIEW**
Breakdown based
on Category

Overall Poster Authors Analysis

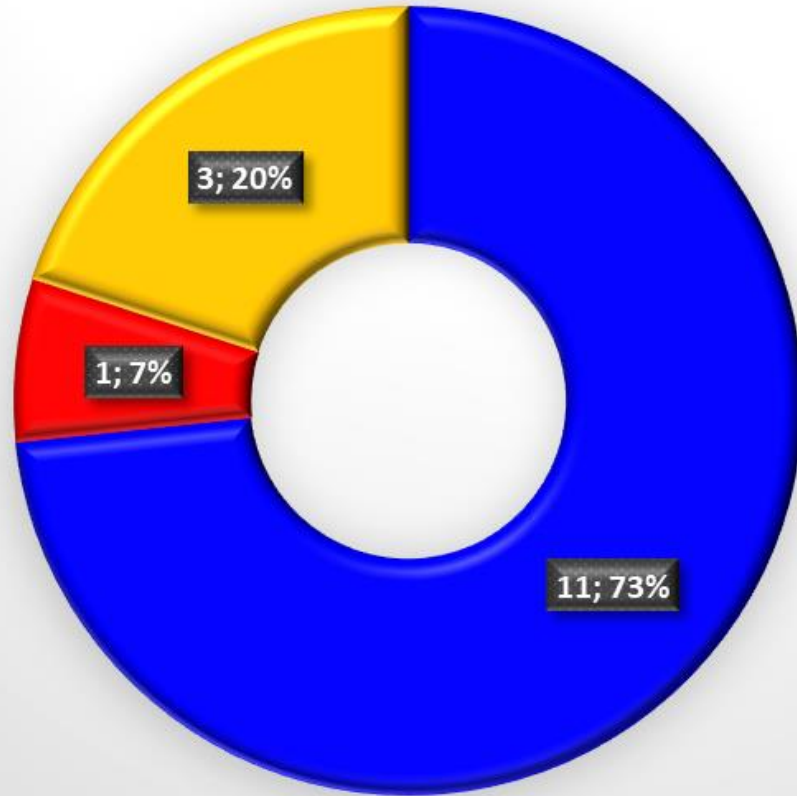

- Standard Poster
- Student Poster
- Aindt_Author

Summary

Standard Poster	11
Student Poster	1
AINDT_Author	3
Total	15

ATTENDANCE
OVERVIEW
Breakdown based
on Category

Overall Walk-In Analysis

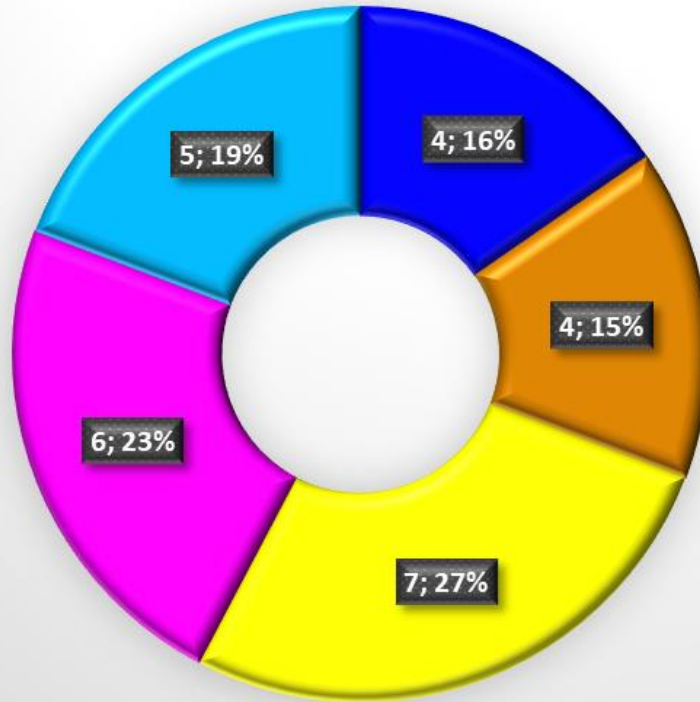

- Accompanying Person
- One Day Conference Pass
- NDTSS registration
- Exhibition Only
- General

Summary

Accompanying Person	4
One Day Conference Pass	4
NDTSS Registration	7
Exhibition Only	6
General	5
Total	26

ATTENDANCE
OVERVIEW
Breakdown based
on Category

Overall Exhibitor Analysis

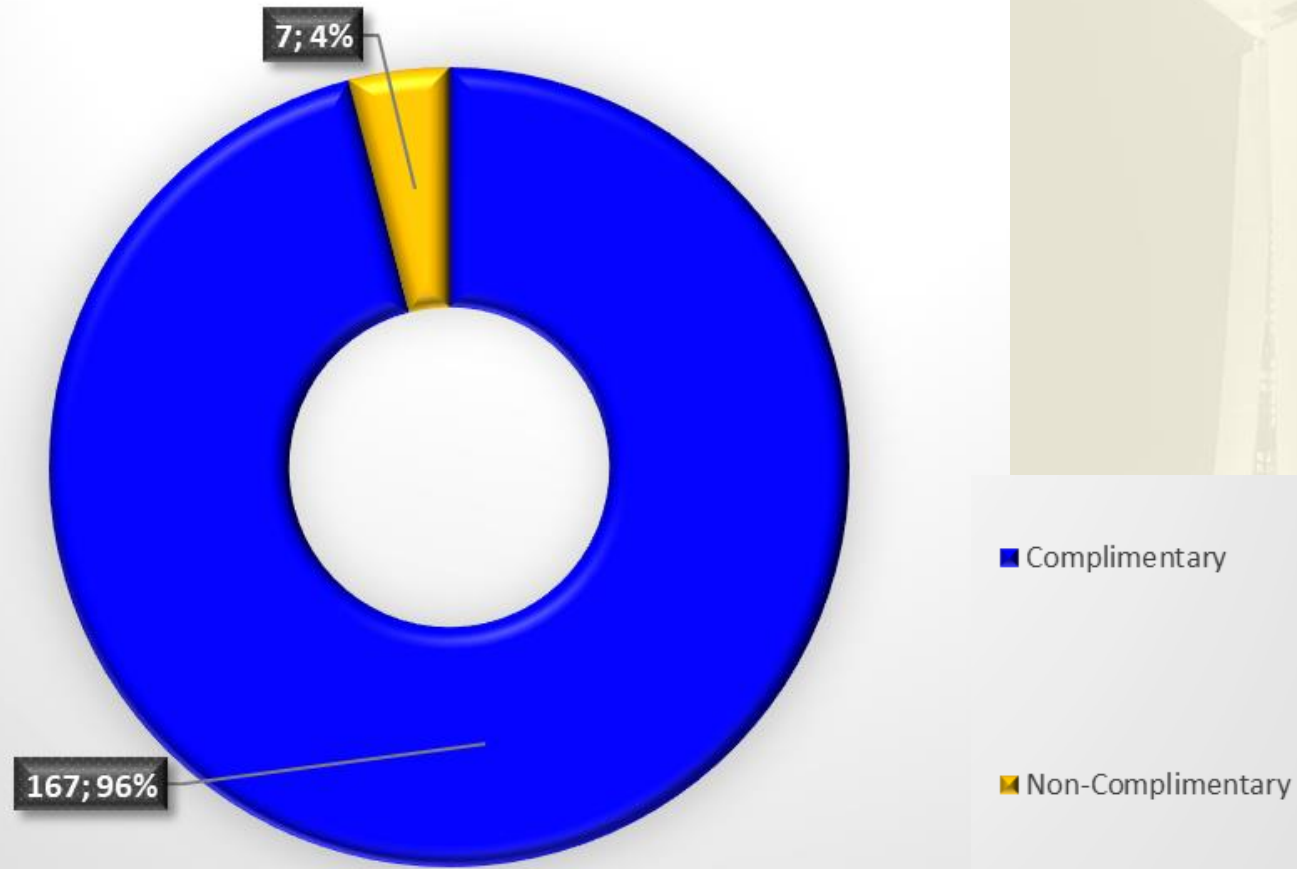

Summary	
Complimentary (entitlement)	167
Non-Complimentary (paid)	7
Total	174

Note: Do not include daily Trade Visitor Pass

ATTENDANCE OVERVIEW

For 4 days Trade Visitor Pass

Summary

Day 1 – Trade Visitor	139
Day 1- Extra Exhibitor Pass	26
Day 2 – Trade Visitor	207
Day 2- Extra Exhibitor Pass	37
Day 3 – Trade Visitor	185
Day 3- Extra Exhibitor Pass	47
Day 4 – Trade Visitor	177
Day 4- Extra Exhibitor Pass	35
Total	853

Day 1

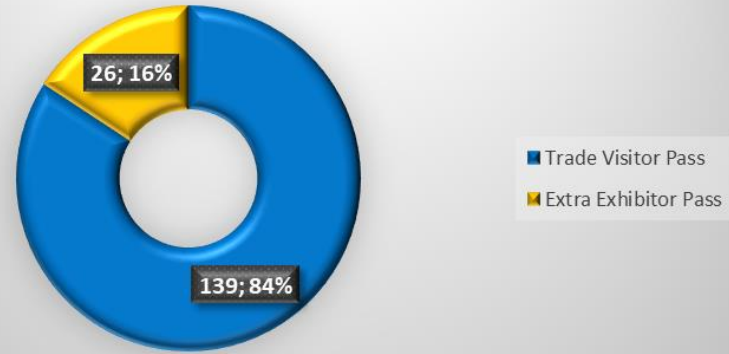

Day 2

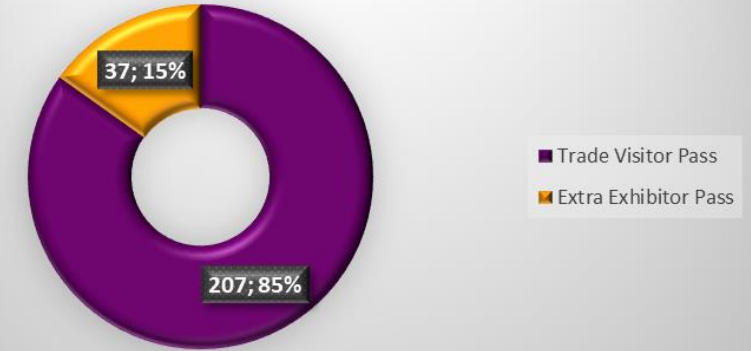

Day 3

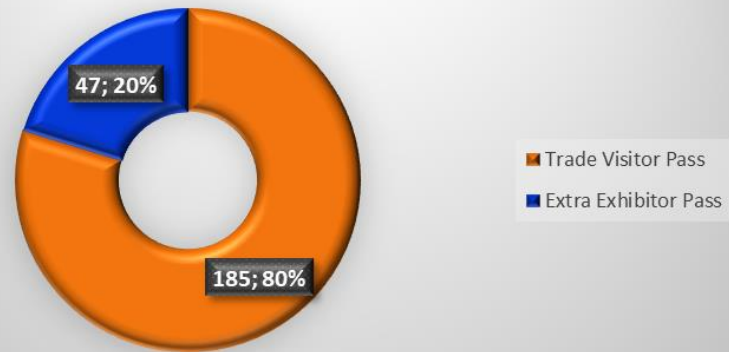

Day 4

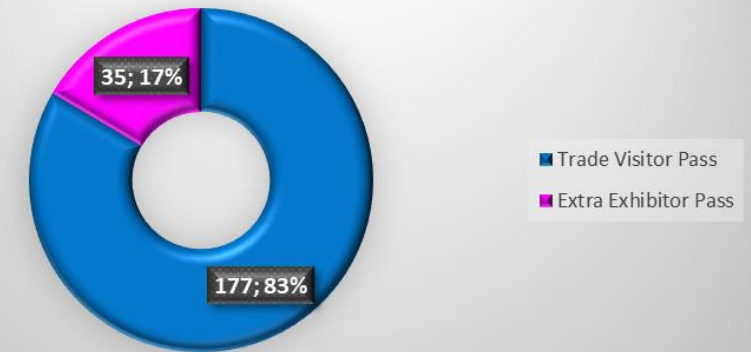

ATTENDANCE
OVERVIEW
Breakdown based
on Country

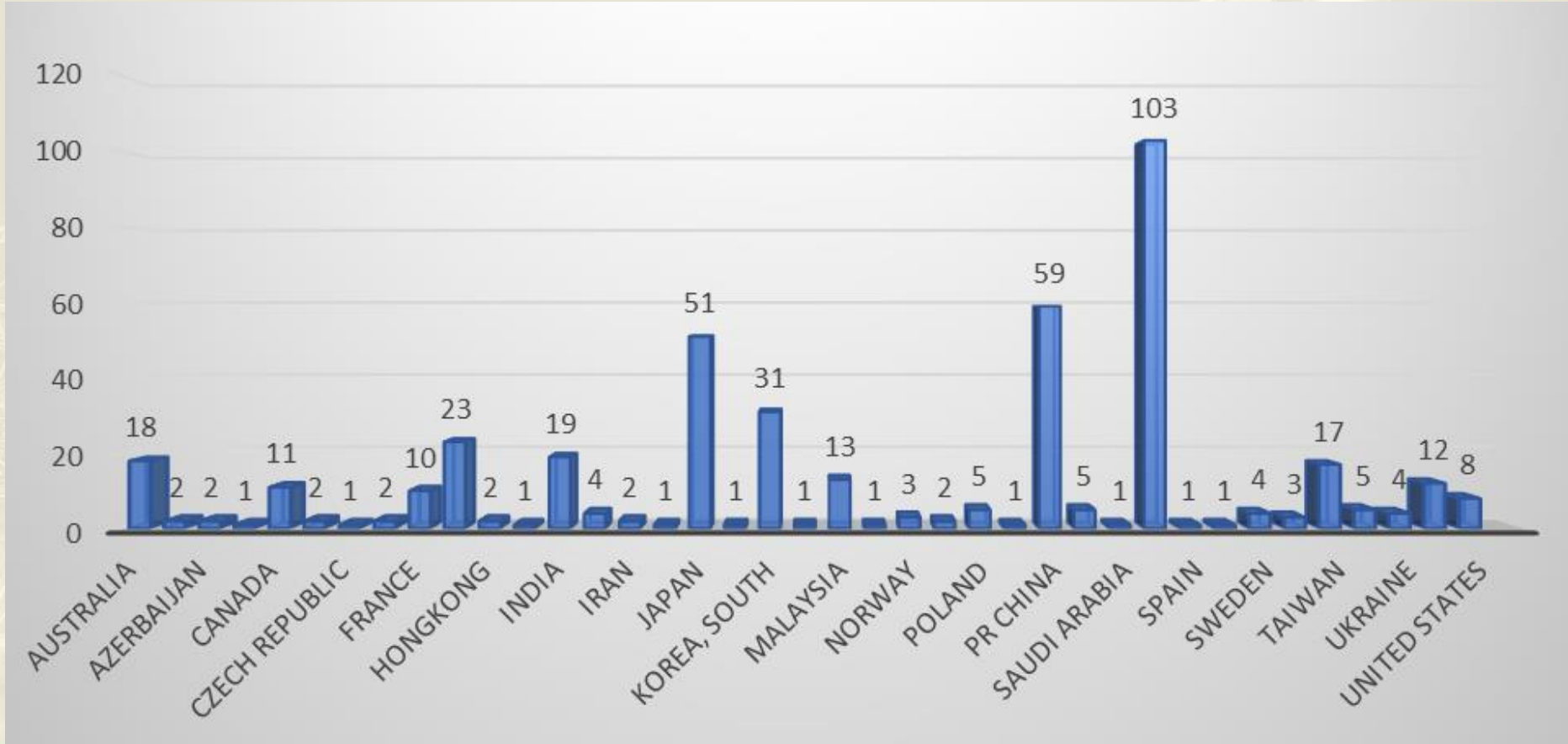

ATTENDANCE DAY 1

15th APCNDT 2017
SINGAPORE

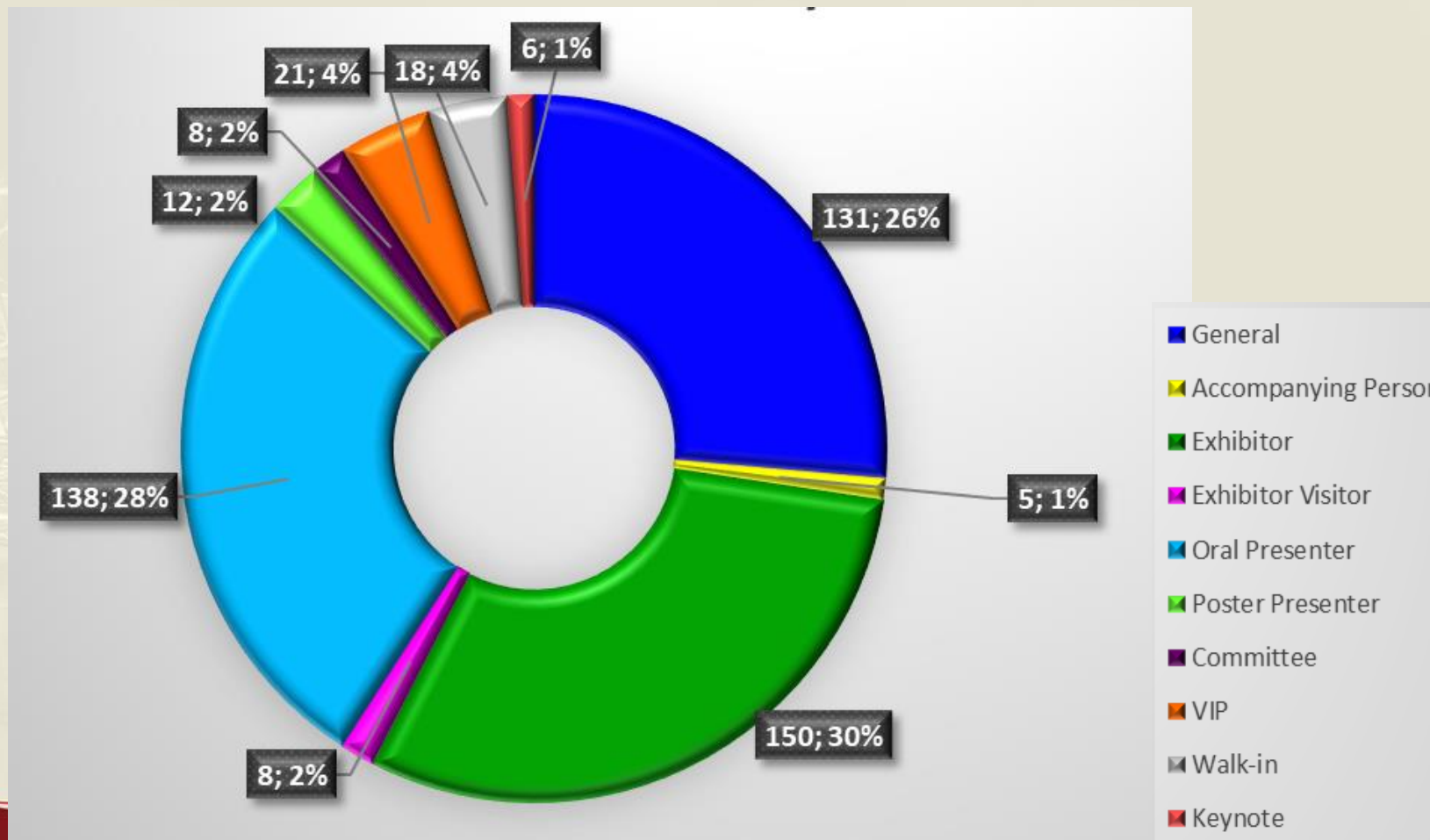

Summary	
General	131
Accompanying Person	5
Oral Presenter	138
Poster Presenter	12
Keynote	6
VIP	21
Committee	8
Exhibitor	150
Exhibitor Visitor	8
Walk-In	18
Total	497

APCNDT

ATTENDANCE DAY 2

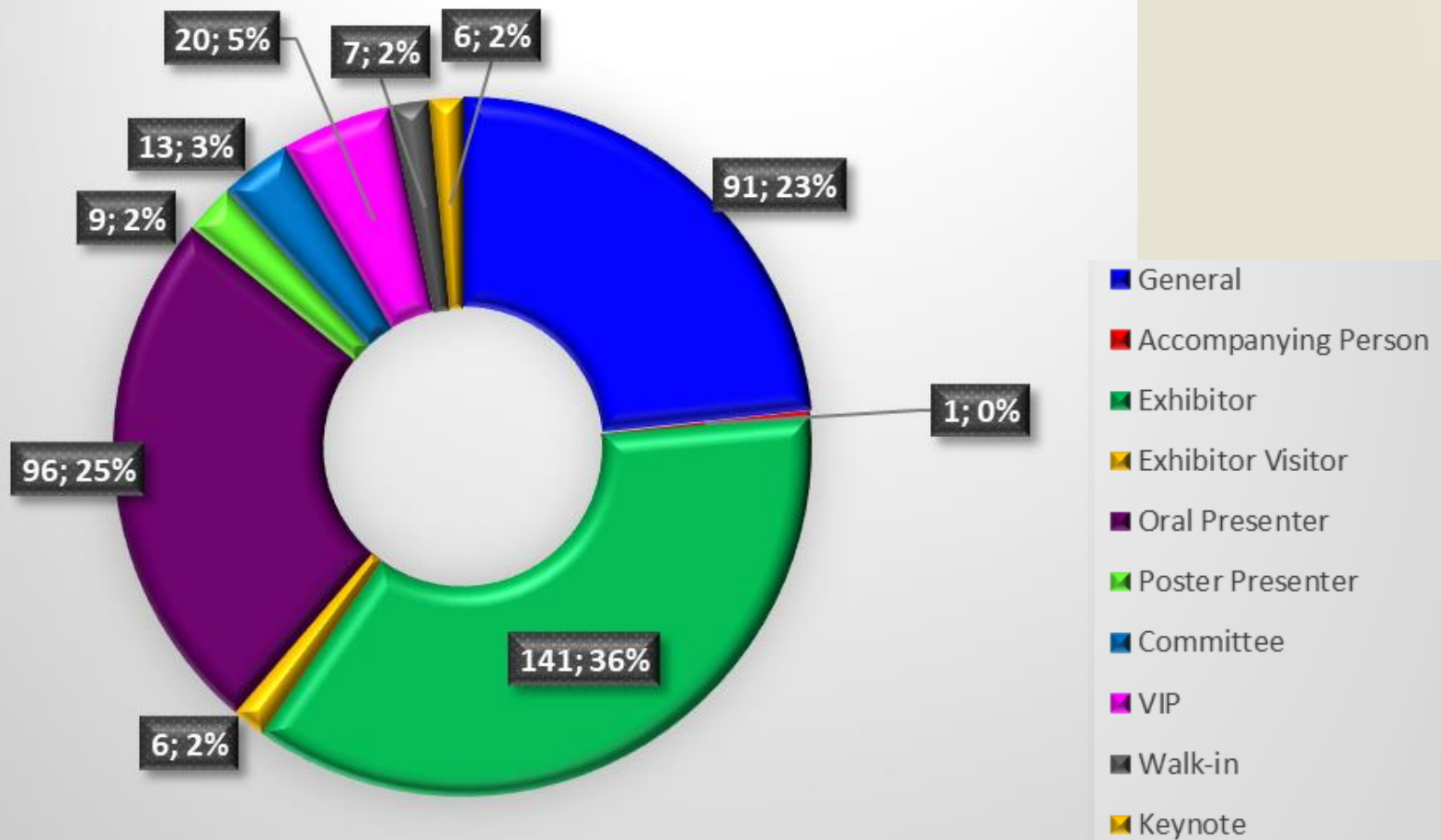

Summary	
General	91
Accompanying Person	1
Oral Presenter	96
Poster Presenter	9
Keynote	6
VIP	20
Committee	13
Exhibitor	141
Exhibitor Visitor	6
Walk-In	7
Total	390

ATTENDANCE DAY 3

15th APCNDT 2017
SINGAPORE

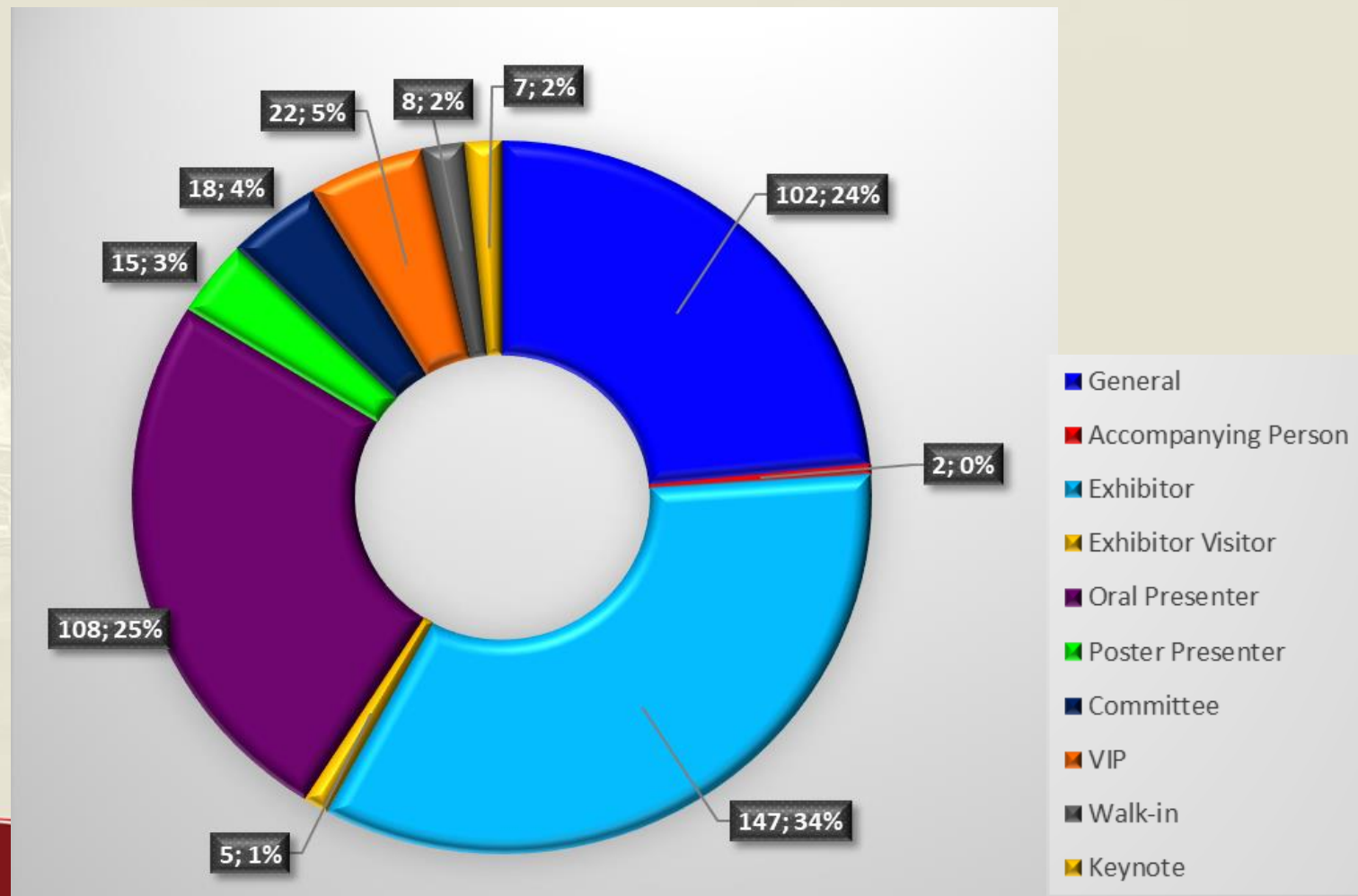

Summary	
General	102
Accompanying Person	2
Oral Presenter	108
Poster Presenter	15
Keynote	7
VIP	22
Committee	18
Exhibitor	147
Exhibitor Visitor	5
Walk-In	8
Total	434

APCNDT

ATTENDANCE DAY 4

15th APCNDT 2017
SINGAPORE

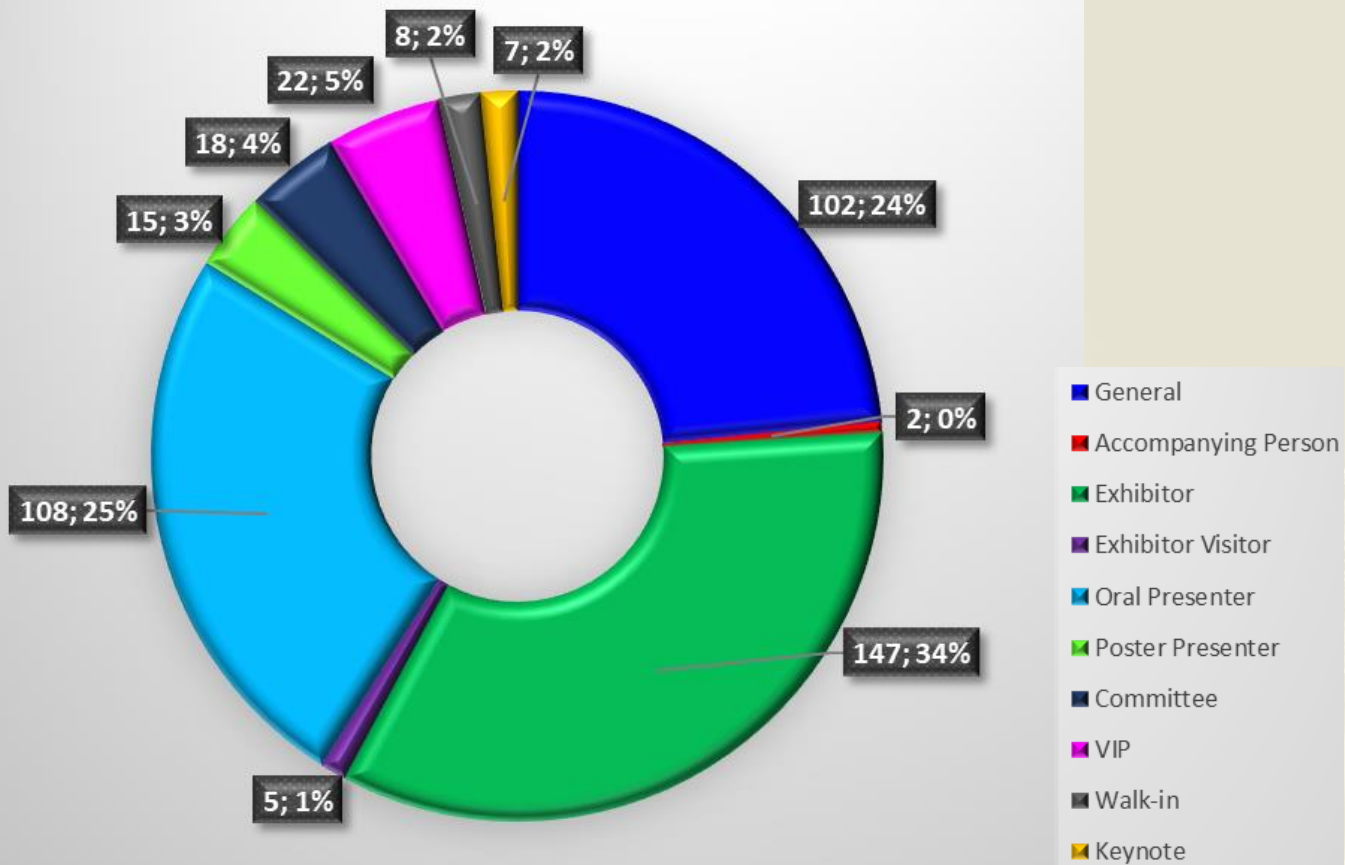

Summary	
General	74
Accompanying Person	0
Oral Presenter	77
Poster Presenter	4
Keynote	6
VIP	17
Committee	15
Exhibitor	142
Exhibitor Visitor	0
Walk-In	5
Total	340

ATTENDANCE DAY 5

15th APCNDT 2017
SINGAPORE

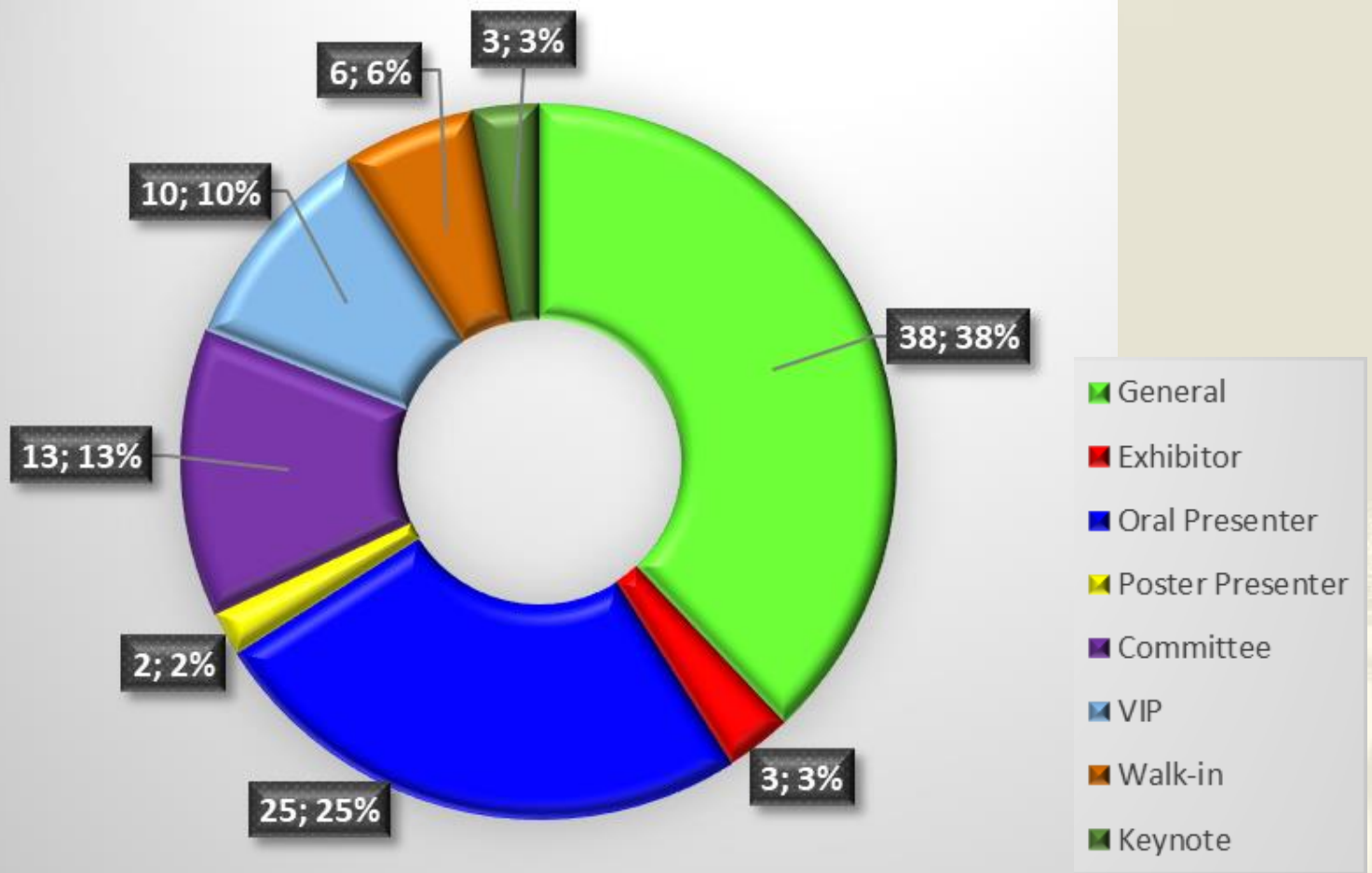

Summary	
General	38
Accompanying Person	0
Oral Presenter	25
Poster Presenter	2
Keynote	3
VIP	10
Committee	13
Exhibitor	3
Exhibitor Visitor	0
Walk-In	6
Total	100

List of Exhibitors

15th APCNDT 2017
SINGAPORE

Name of Organisation	Country	Booth
Acoustic Control Systems (ACSYS)	Russia	BR-1
Advanced OEM Solutions	USA	ST-15
American Society for Nondestructive Testing, Inc	USA	ST-7
ANSA WENS Quality Assurance	Singapore	BR-22
APCNDT2021/AINDT/APFNDT/NDTSS	Australia	ST-12
A-Star Testing & Inspection (S) Pte Ltd	Singapore	ST-28
Beijing Dragon Electronics Co	PR China	BR-25
Beijing Guodian NDT Co. Ltd	PR China	ST-2
Callington Group of Companies	Australia	ST-20
Careray Digital Medical System Co. Ltd	PR China	BR-16
Comet AG	Switzerland	SI-9
Cygnus Instruments	UK	BR-10
Daegu Convention & Visitors Bureau	South Korea	ST-13
Dandong Aolong Radiative Instrument Group Co Ltd	PR China	SI-7
Eddyfi Technologies	Canada	SI-11/12
Ether Nde Limited	UK	DI-5
Extende SA	France	ST-3
FEI SAS	France	BR-2
Fischer Instrumentation (S) Pte Ltd	Singapore	ST-9
FORCE Technology	Denmark	ST-23/24

APCNDT

List of Exhibitors

15th
APCNDT 2017
SINGAPORE

Name of Organisation	Country	Booth
GammaTec Aseana NDT Supplies Sdn Bhd	Malaysia	BR-11
GE	Singapore	DI-2
Gilardoni S.P.A.	Italy	ST-1
Guangdong Goworld Co Ltd Ultrasonic Instrument Branch	PR China	BR-7
Guangzhou Doppler Electronic Technologies Co Ltd	PR China	BR-15
Guided Ultrasonics Ltd	UK	BR-28
Hakuto Singapore Pte Ltd	Singapore	ST-25
INETEC-Institute for Nuclear Technology	Croatia	BR-26
iRay Technology (Shanghai) Limited	PR China	BR-31
IRC Engineering Services (India) Pvt Ltd	India	ST-16
Keiyu NDT Supply Co	Taiwan	BR-23
Keiyu NDT Supply Co	Taiwan	BR-18
Kowotest GMBH	Germany	BR-14
Labino AB	Sweden	DI-4
Logos Imaging LLC	USA	BR-5
Lucky Healthcare Co Ltd	PR China	ST-21/22
Luke Testing Instruments Ltd	PR China	BR-3
M2M	France	SI-6
Matrix U/E Technologies Limited	PR China	ST-6
Micro-Tech Supplies & Services Pte Ltd	Singapore	GO-1

APCNDT

List of Exhibitors

15th APCNDT 2017
SINGAPORE

Name of Organisation	Country	Booth
MITCORP	Taiwan	BR-17
MITEC Co. Ltd	PR China	ST-18
Modsonic Instruments Mft	India	BR-6
MR Chemie India Pvt Ltd	India	ST-8
Nantong Union Digital Technology Development Co	PR China	ST-14
National Centre for Nuclear Research Radioisotope Centre POLATOM	Poland	BR-21
NDT Instruments Pte Ltd	Singapore	PL-1
NDT Seals Inc	USA	ST-5
NDT Systems	USA	SI-13
NOVO DR Ltd	Israel	GO-2
Olympus	USA	DI-3
Oxford Instruments	Singapore	ST-4
Pfinder KG	Germany	BR-24
PMB-Alcen	France	BR-27
Proceq Asia	Singapore	SI-4
PRP (OKO Association)	Ukraine	SI-10
ScanMaster Systems	Israel	BR-32
SECU-CHEK GmbH	Germany	ST-19
Sentinel Asia Ltd	South Korea	SI-8
Shanghai CHiNDT Systems & Services Co. Ltd	PR China	BR-9
Shantou Institute of Ultrasonic Instruments Co. Ltd	PR China	BR-12

APCNDT

List of Exhibitors

15th APCNDT 2017
SINGAPORE

Name of Organisation	Country	Booth
Shenzhen Yateks Optical Electronic Technology Co. Ltd	PR China	BR-8
Shimadzu	Japan	SI-2
Sonaspection	UK	SI-1
Sonatest Ltd	UK	BR-13
SONOTEC Ultraschallsensorik Halle GmbH	Germany	ST-26/27
Swedish NDT Society/ECNDT2018	Sweden	ST-10
Tecnar Automation Ltee	Canada	BR-4
Teledyne ICM	Belgium	SI-3
Varex Imaging	UK	ST-17
Volume Graphics GmbH	Germany	BR-29
WCNDT2020/KSNT	South Korea	ST-11
Zhejiang URT Test Technology Co Ltd	PR China	BR-20
Zhengzhou Runde Dellonscope Co Ltd	PR China	BR-19
Zhongke Innovation Technology Co Ltd	PR China	BR-30

APCNDT



Passion
Made
Possible

15th
APCNDT 2017
SINGAPORE

APCNDT

Organised by:

